

# For Round Poles, 18" Banner

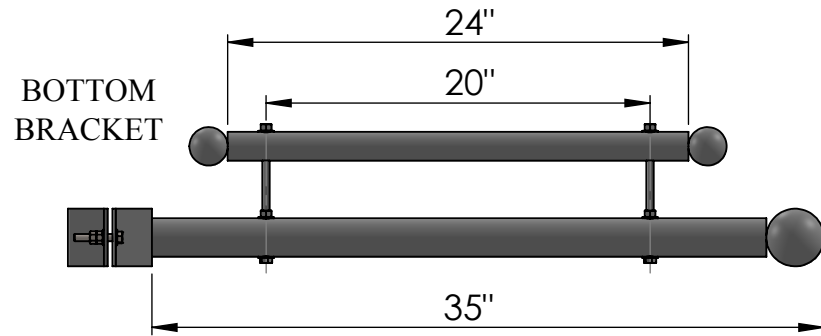

**FRONT VIEW**

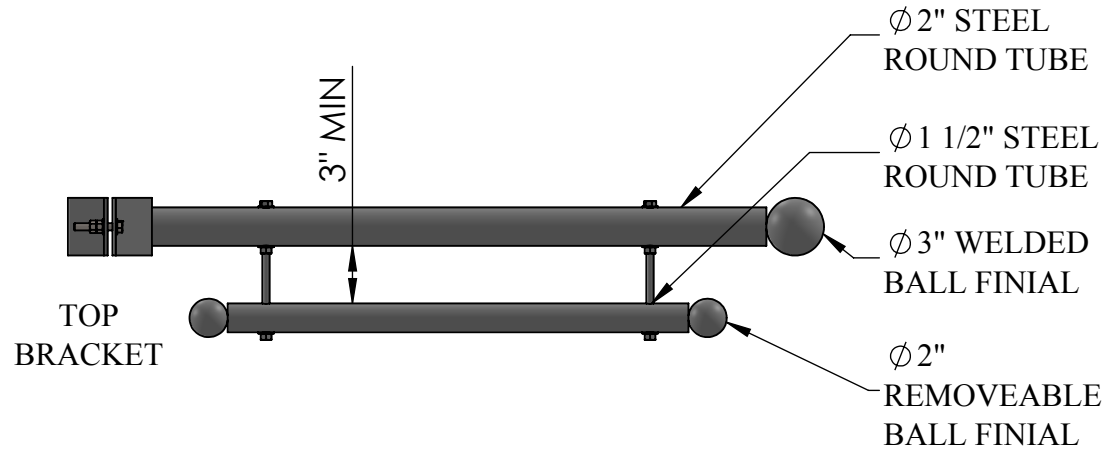
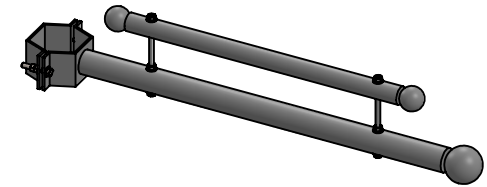
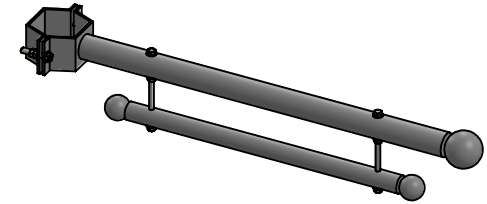

Ø 2" STEEL ROUND TUBE

Ø 1 1/2" STEEL ROUND TUBE

Ø 3" WELDED BALL FINIAL

Ø 2" REMOVEABLE BALL FINIAL

Custom clamps available for poles of diameter/width 3" to 8". Pole shape/size specified by customer at time of order.

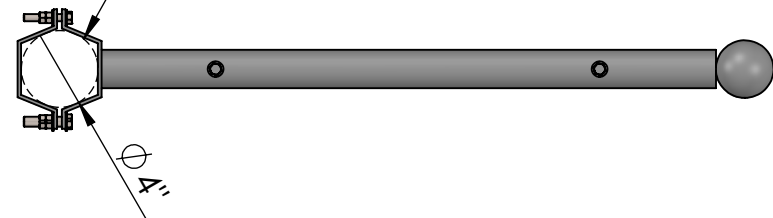

**TOP VIEW**

Date: 05/2015  
Scale: NTS  
CB:  
Order#:

Content: Trapeze Banner 1-Way Bracket for 18" Banner  
PN: 303B-1WSET-18  
Color/Finish: Textured Black Powder Coat  
Customer Approval: \_\_\_\_\_

Design by Sign Bracket Store. All visual representations and designs are the intellectual property of Sign Bracket Store and protected under copyright law. Any duplication of this design is in direct violation of the law and will result in legal action.  
© Copyright 2008-2015



T: 888-919-7446

F: 760-603-0812

# For Square Poles, 18" Banner

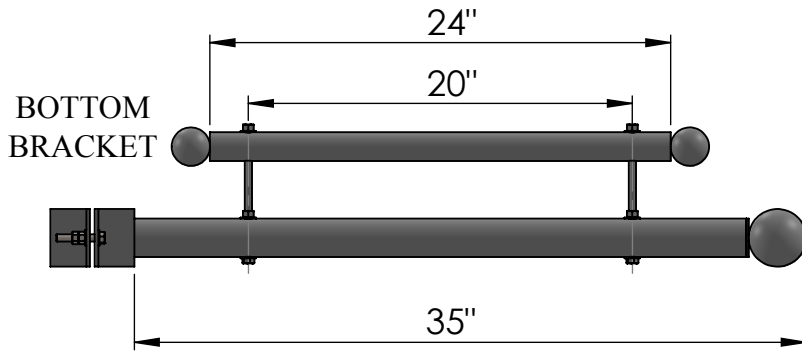
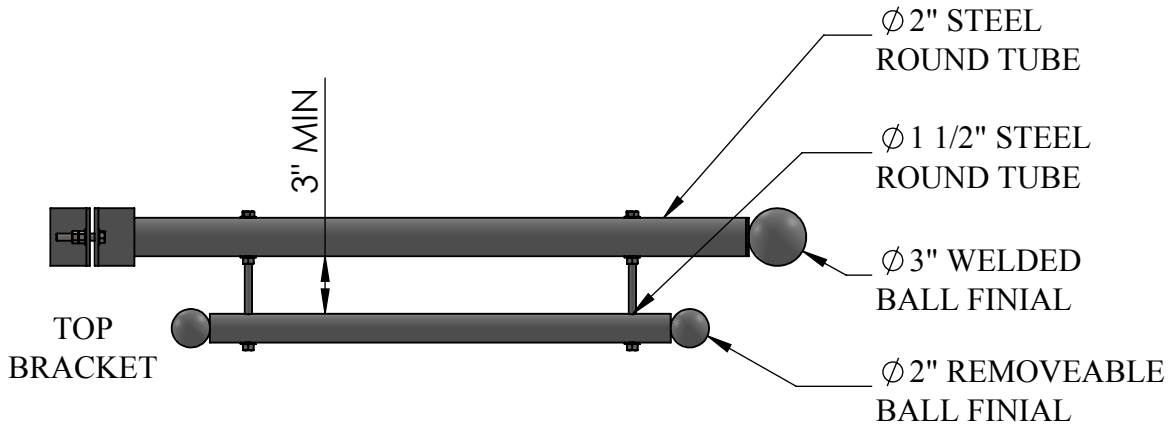

**FRONT VIEW**

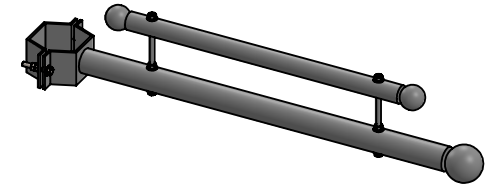
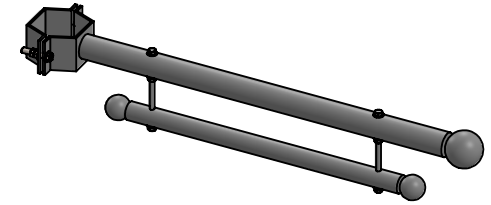

Ø 2" STEEL ROUND TUBE

Ø 1 1/2" STEEL ROUND TUBE

Ø 3" WELDED BALL FINIAL

Ø 2" REMOVEABLE BALL FINIAL

Custom clamps available for poles of diameter/width 3" to 8". Pole shape/size specified by customer at time of order.

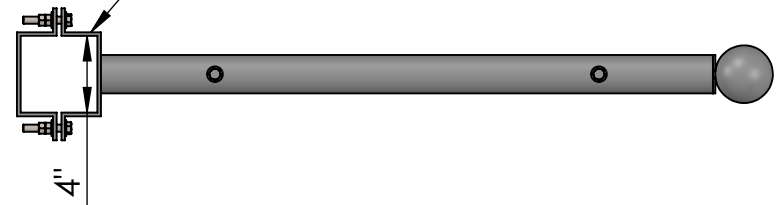

**TOP VIEW**

Date: 05/2015  
Scale: NTS  
CB:  
Order#:

Content: Trapeze Banner 1-Way Bracket for 18" Banner  
PN: 303B-1WSET-18  
Color/Finish: Textured Black Powder Coat  
Customer Approval: \_\_\_\_\_

Design by Sign Bracket Store. All visual representations and designs are the intellectual property of Sign Bracket Store and protected under copyright law. Any duplication of this design is in direct violation of the law and will result in legal action.  
© Copyright 2008-2015



T: 888-919-7446

F: 760-603-0812