

Channel Depth is 3/4"

3" Long

* Comes w/ Protective Plastic Film

Hole diameter, location, and spacing for each end on all direct sign mounts up to 24" in length.

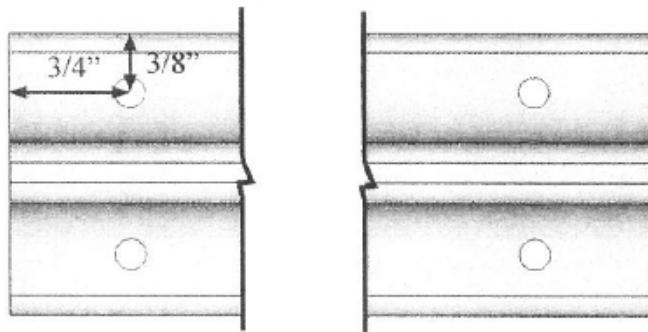

TOP VIEW

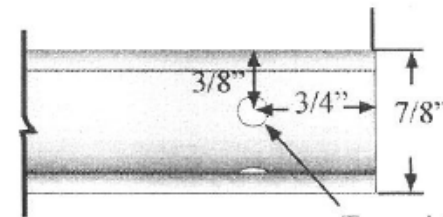

Tapped Set Screw Hole Placement, 3/16" Dia Hole

Hole Placement is the same on both ends.

SIDE VIEW

Date: 10/2012
 Sheet
 Scale: NTS
 DB: KE
 CB:
 Inv:

Content: Direct Sign Mount for 1/8" Substrate
 SKU: DSM-18-3-N
 Color/Finish: Mill/Natural Finish w/ Protective Plastic Film

Customer Approval: _____

Design by Sign Bracket Store. All visual representations and designs are the intellectual property of Sign Bracket Store and protected under copyright law. Any duplication of this design is in direct violation of the law and will result in legal action.
 © Copyright 2008-2012

SIGN BRACKET STORE

By Hooks & Lattice  SignBracketStore.com

T:888-919-7446

F:760-603-0812