

SIDE VIEW

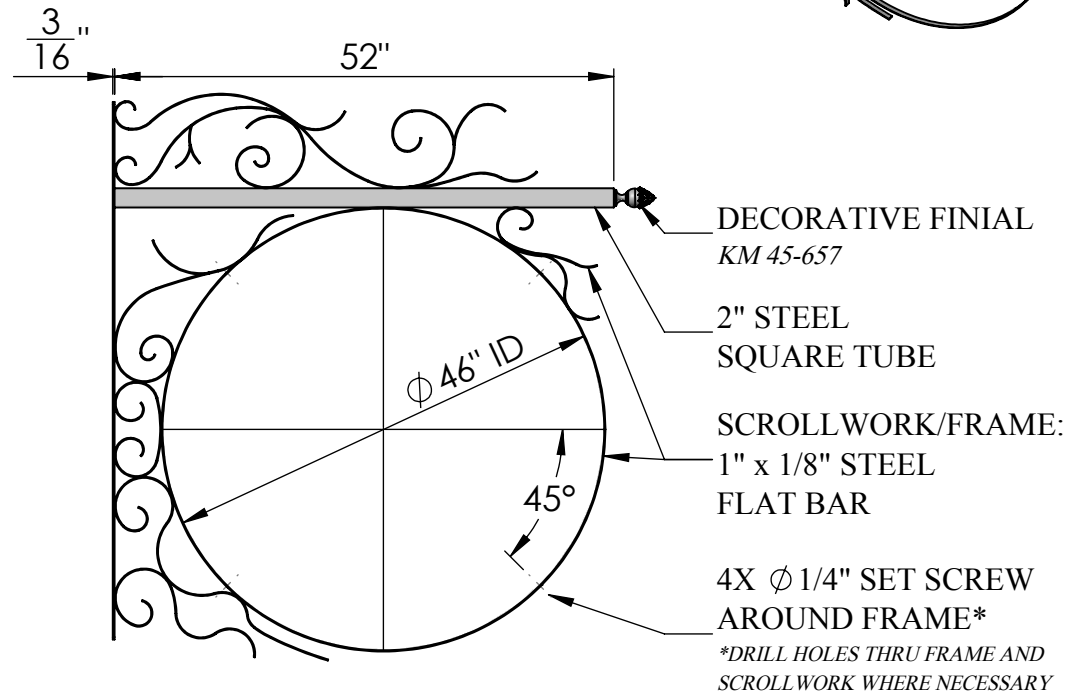

FRONT VIEW

DECORATIVE FINIAL
KM 45-657

2" STEEL
SQUARE TUBE

SCROLLWORK/FRAME:
1" x 1/8" STEEL
FLAT BAR

4X Ø 1/4" SET SCREW
AROUND FRAME*

*DRILL HOLES THRU FRAME AND
SCROLLWORK WHERE NECESSARY

Date: 09/2015
Scale: NTS
DB: CF
CB:
Order#:

Content: 52" Round Scroll Bavarian Fixed Frame Bracket
PN: 390B-RND-52
Color/Finish: Textured Black Powder Coat
Customer Approval: _____

Design by Sign Bracket Store. All visual representations and designs are the intellectual property of Sign Bracket Store and protected under copyright law. Any duplication of this design is in direct violation of the law and will result in legal action.
© Copyright 2008-2015



T: 888-919-7446

F: 760-603-0812