

WEIGHT: ~7-lbs

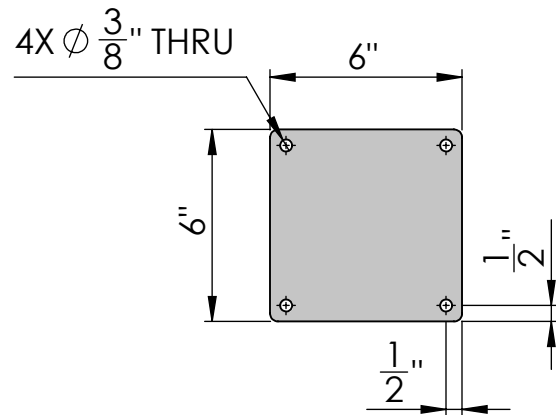

SIDE VIEW

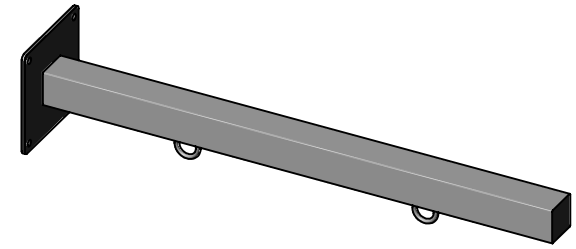
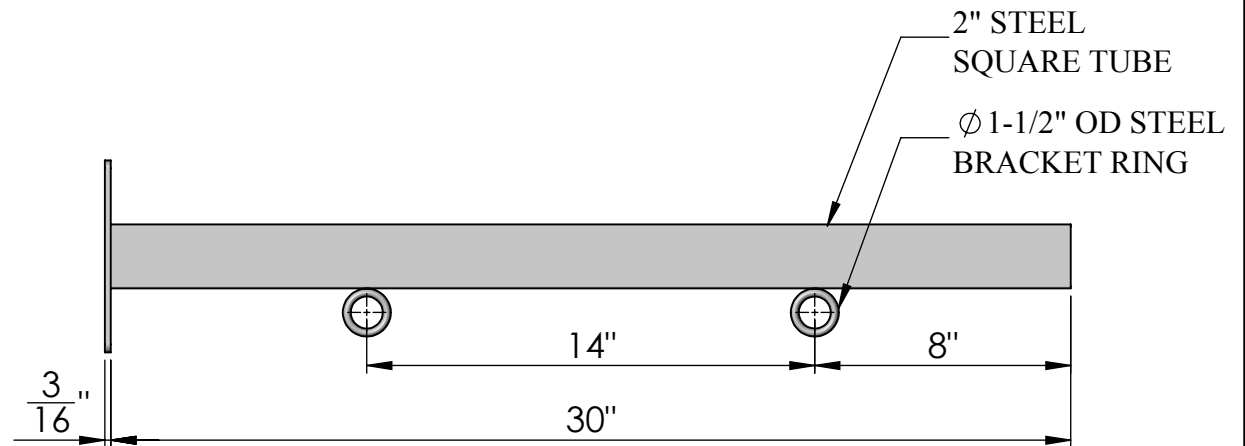

FRONT VIEW

Date: 06/2015
Scale: NTS
CB:
Order#:

Content: 30" Straight Arm Sign Bracket with Rings
PN: 379B-30-WR
Color/Finish: Textured Black Powder Coat
Customer Approval: _____

Design by Sign Bracket Store. All visual representations and designs are the intellectual property of Sign Bracket Store and protected under copyright law. Any duplication of this design is in direct violation of the law and will result in legal action.
© Copyright 2008-2015



T: 888-919-7446

F: 760-603-0812