

**SIDE VIEW**

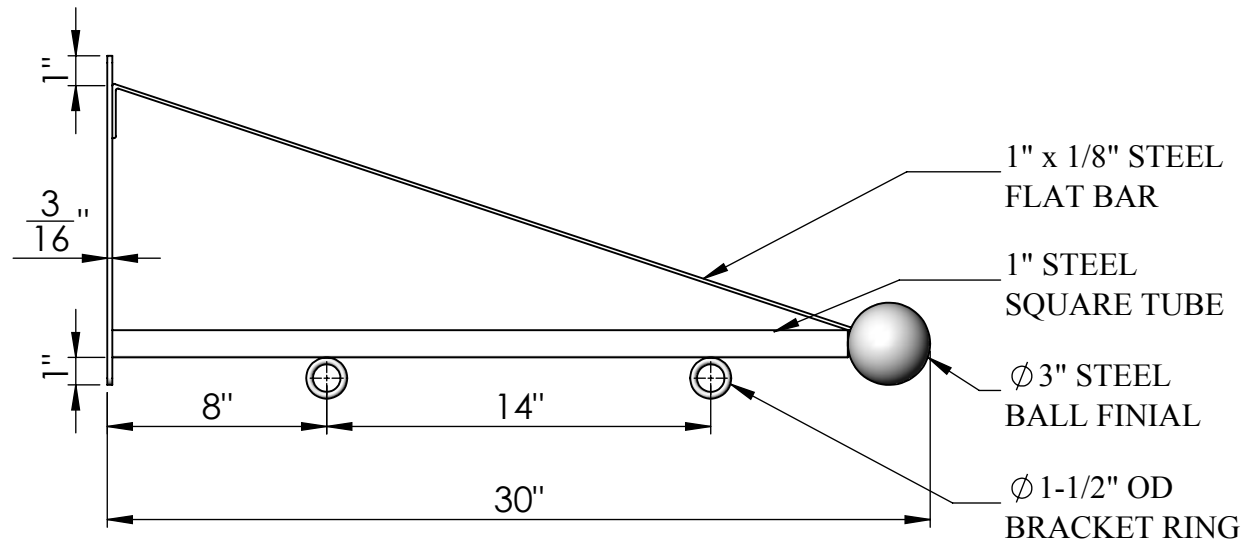

**FRONT VIEW**

Date: 06/2015  
 Scale: NTS  
 DB: CF  
 CB:  
 Order#:

Content: 30" White Triangle Ball Sign Bracket  
 PN: 375B-30-WHT  
 Color/Finish: White Powder Coat  
 Customer Approval: \_\_\_\_\_

Design by Sign Bracket Store. All visual representations and designs are the intellectual property of Sign Bracket Store and protected under copyright law. Any duplication of this design is in direct violation of the law and will result in legal action.  
 © Copyright 2008-2015



T: 888-919-7446

F: 760-603-0812