

NOTES:

1. (3) ϕ 1/2" SIGN MOUNTING HOLES EVENLY SPACED AROUND FRAME

REVISIONS			
REV.	DESCRIPTION	DATE	CB
A	ORIGINAL DRAWING	12/12/2016	ZB

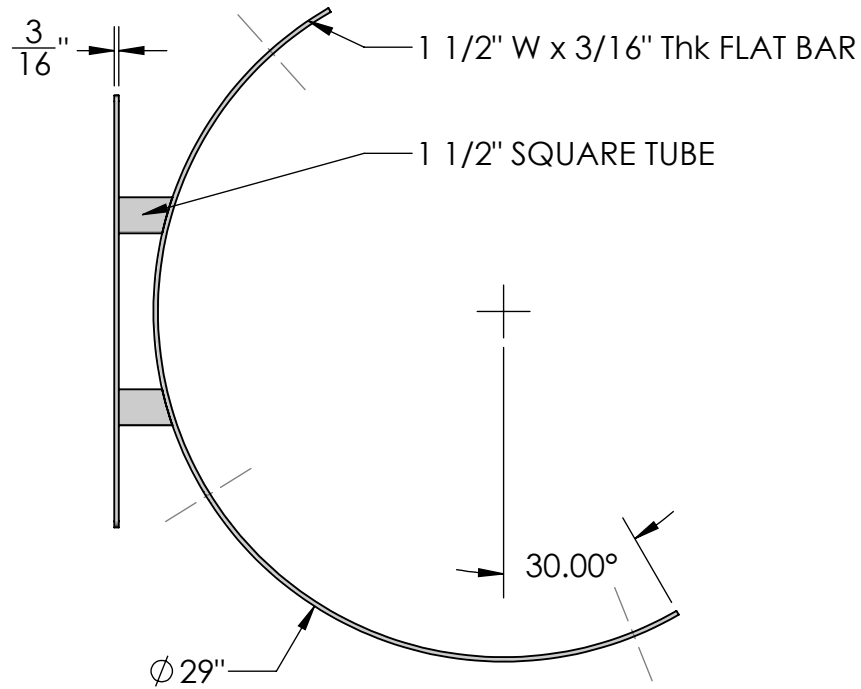

FRONT VIEW

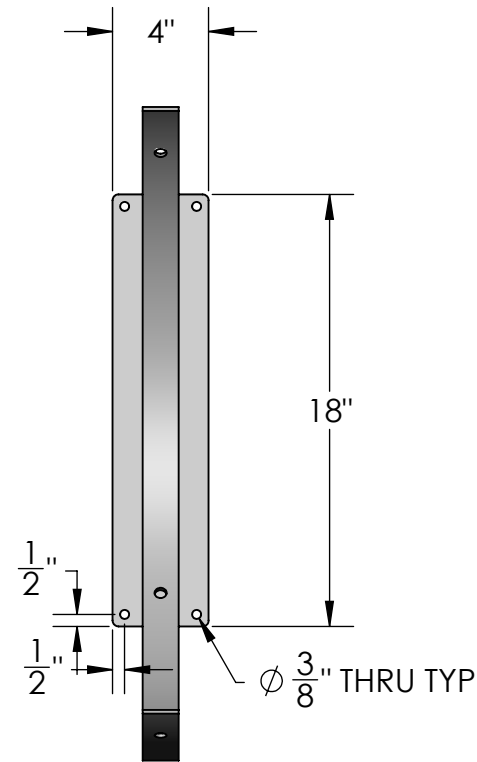

SIDE VIEW

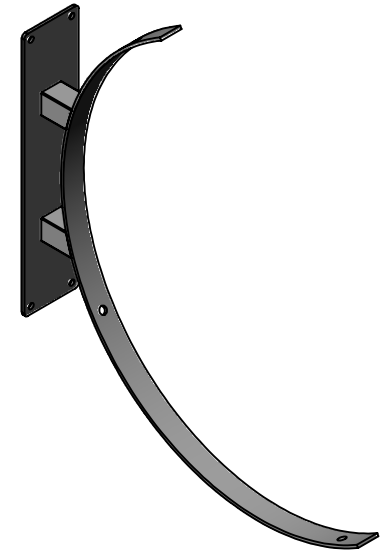

Material:
Steel

Scale: 1:8
DB: ZB
Rev: A
Sheet: 1 of 1

Content: Eclipse 26" Sign Bracket
PN: 406B-26
Color/Finish: Textured Black Powder Coat
Customer Approval: _____

Design by Sign Bracket Store. All visual representations and designs are the intellectual property of Sign Bracket Store and protected under copyright law. Any duplication of this design is in direct violation of the law and will result in legal action.

© Copyright 2008-2017



T: 888-919-7446

F: 760-603-0812