

For Use with Round Poles, 36" W Banner

Hardware Included (PER ARM):

- (2) 5/16"-18 x 6"L Zinc Coated Carriage Bolt
- (6) 5/16"-18 Zinc Coated Hex Nut
- (6) 5/16" Lock Washer
- (6) 5/16" Flat Washer

	Standard Sizes*
Pole Dia./Width (P)	3", 4", 5", 6"

*Custom sizes available, call for details.

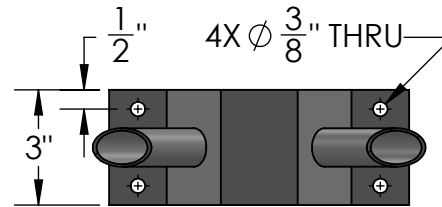

SECTION A-A

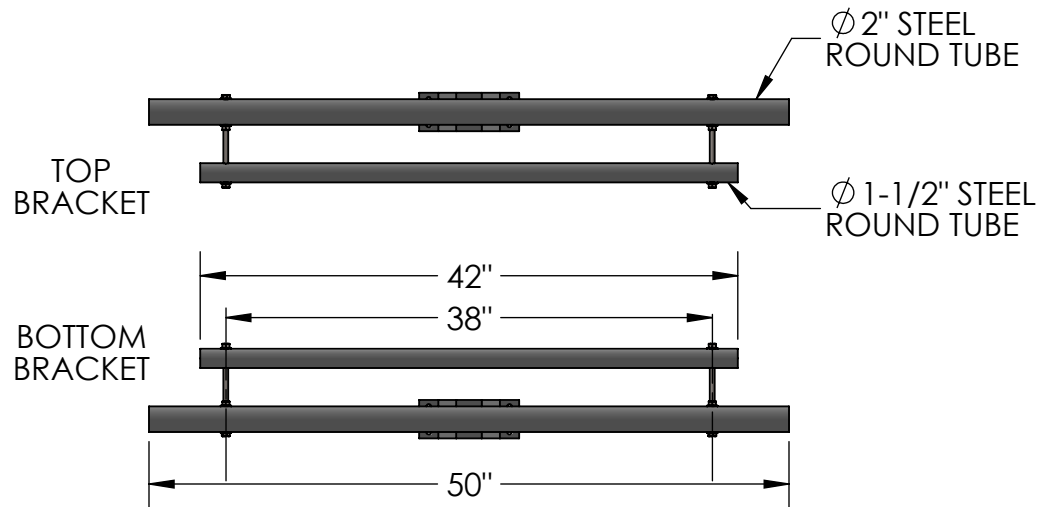
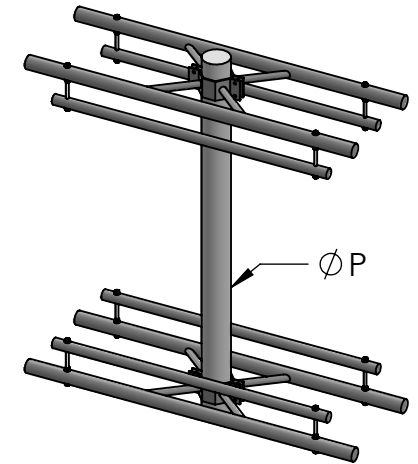

FRONT VIEW

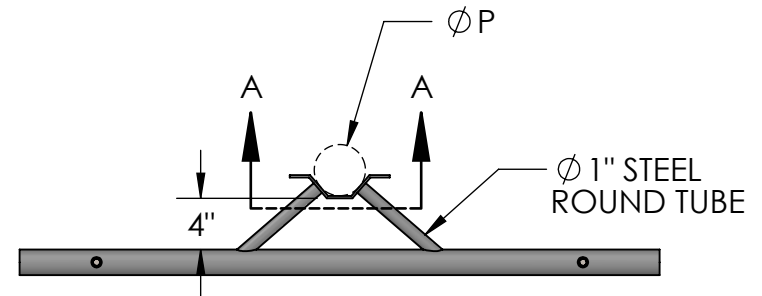

TOP VIEW

Material: Steel

Scale: 1:15
DB: CF
Rev:
Order#:

Content: Mezzo Mount Trapeze Banner 2-Way Bracket Pair, 36" Banner

PN: 303B-MM-2WSET-36

Color/Finish: Textured Black Powder Coat

Customer Approval: _____

Design by Sign Bracket Store. All visual representations and designs are the intellectual property of Sign Bracket Store and protected under copyright law. Any duplication of this design is in direct violation of the law and will result in legal action.

© Copyright 2008-2016

SIGN BRACKET STORE
By Hooks & Lattice  SignBracketStore.com

T: 888-919-7446

F: 760-603-0812

For Use with Square Poles, 36"W Banner

Hardware Included (PER ARM):

- (2) 5/16"-18 x 6"L Zinc Coated Carriage Bolt
- (6) 5/16"-18 Zinc Coated Hex Nut
- (6) 5/16" Lock Washer
- (6) 5/16" Flat Washer

	Standard Sizes*
Pole Dia./Width (P)	3", 4", 5", 6"

*Custom sizes available, call for details.

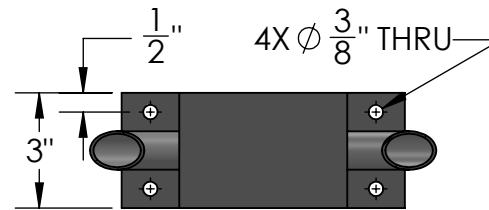

SECTION B-B

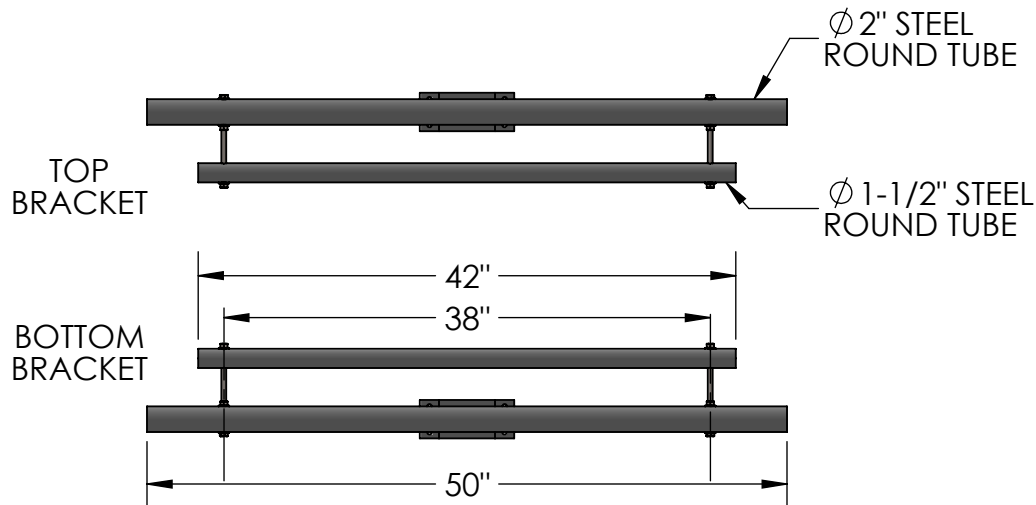
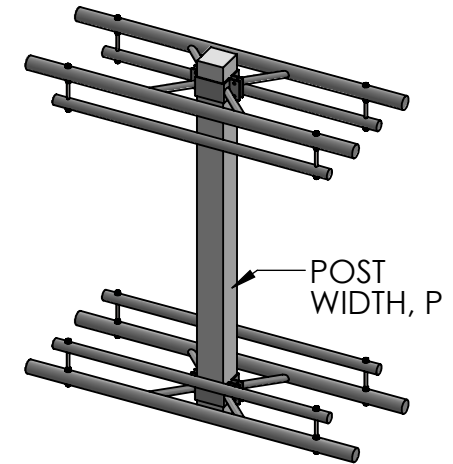

FRONT VIEW

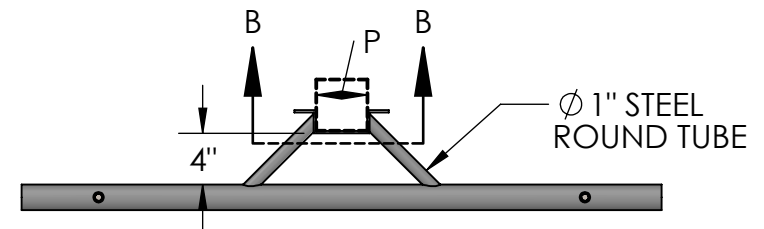

TOP VIEW

Material:
Steel

Scale: 1:15
DB: CF
Rev:
Order#:

Content: Mezzo Mount Trapeze Banner 2-Way Bracket Pair, 36" Banner

PN: 303B-MM-2WSET-36

Color/Finish: Textured Black Powder Coat

Customer Approval: _____

Design by Sign Bracket Store. All visual representations and designs are the intellectual property of Sign Bracket Store and protected under copyright law. Any duplication of this design is in direct violation of the law and will result in legal action.

© Copyright 2008-2016

SIGN BRACKET STORE
By Hooks & Lattice  SignBracketStore.com

T: 888-919-7446

F: 760-603-0812