

NOTES:

1. All aluminum construction.
2. UL Listed.
3. Available with alternate arm configurations.
4. Powder coat finished. See website for color options.

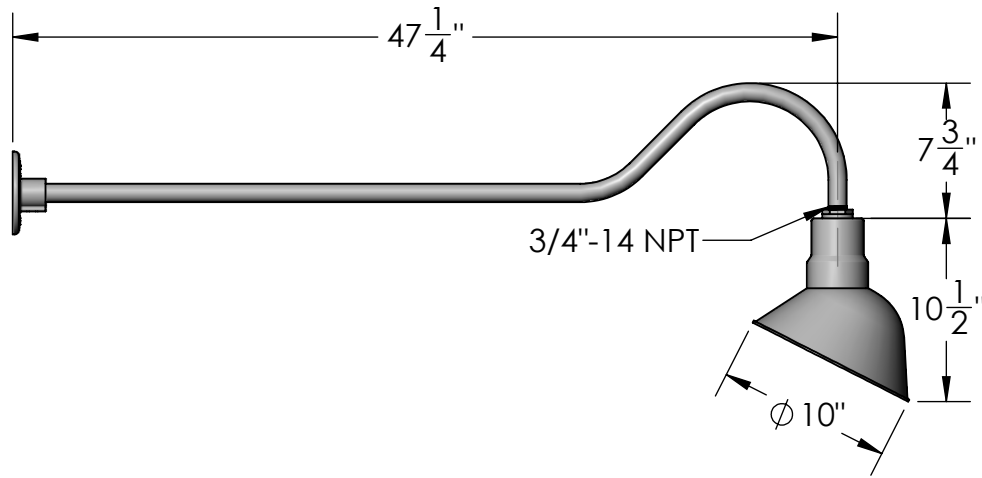

FRONT VIEW

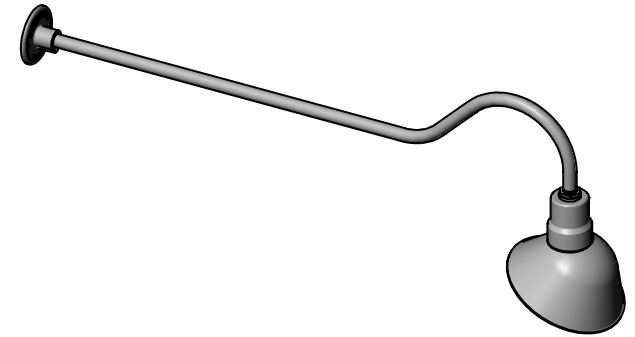
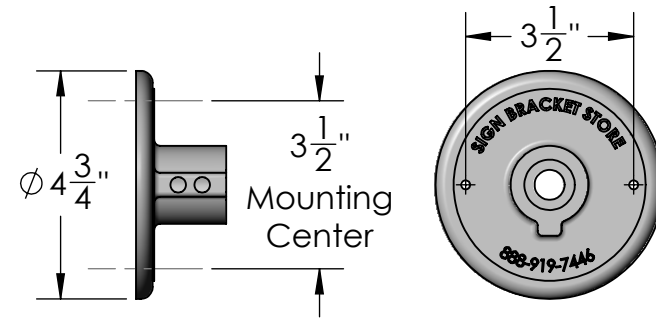
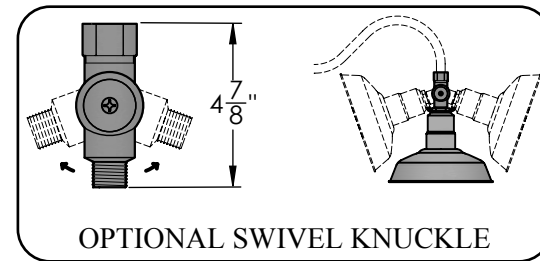

Bottom View

Front View

MOUNTING DETAIL

Date: 09/2015
 Scale: NTS
 DB: CF
 CB:
 Order#:

Content: Gooseneck Light-47-1/4"L x 3/4" Dia. Arm, 10" Angle Shade
 PN: SL8-AE7-ANG810
 Color/Finish:
 Customer Approval: _____

Design by Sign Bracket Store. All visual representations and designs are the intellectual property of Sign Bracket Store and protected under copyright law. Any duplication of this design is in direct violation of the law and will result in legal action.
 © Copyright 2008-2015



T: 888-919-7446

F: 760-603-0812